

┌	┐	└	┌	┐	└	┌	┐	└
└	+	└	└	+	└	└	+	└
└	└	└	└	└	└	└	└	└

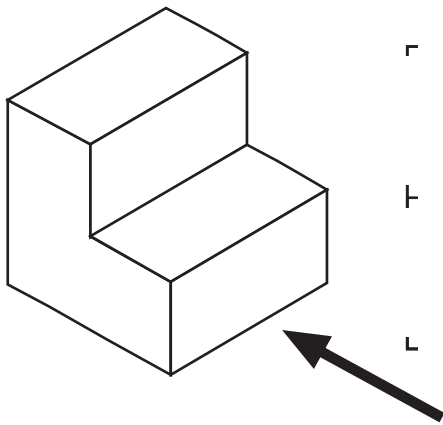

┌	┐	└
└	+	└
└	└	└

┌	┐	└	┌	┐	└	┌	┐	└
└	+	└	└	+	└	└	+	└
└	└	└	└	└	└	└	└	└

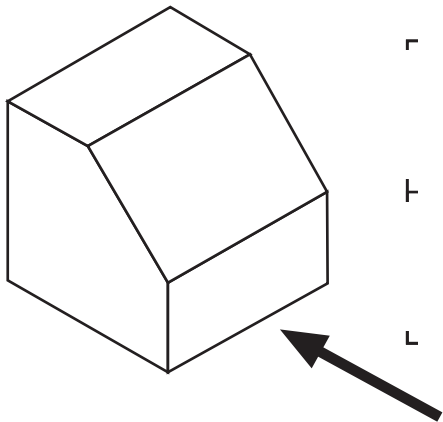

┌	┐	└
└	+	└
└	└	└

┌      ─      ㄣ      ┌      ─      ㄣ      ┌      ─      ㄣ

└      +      ㄣ      └      +      ㄣ      └      +      ㄣ

└      ⊥      ㄣ      └      ⊥      ㄣ      └      ⊥      ㄣ

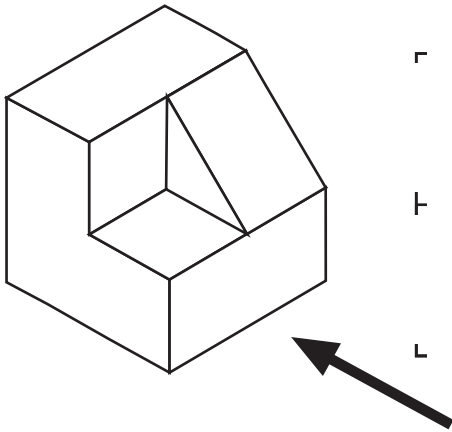

┌      ─      ㄣ

└      +      ㄣ

└      ⊥      ㄣ

┌      ─      ㄣ      ┌      ─      ㄣ      ┌      ─      ㄣ

└      +      ㄣ      └      +      ㄣ      └      +      ㄣ

└      ⊥      ㄣ      └      ⊥      ㄣ      └      ⊥      ㄣ

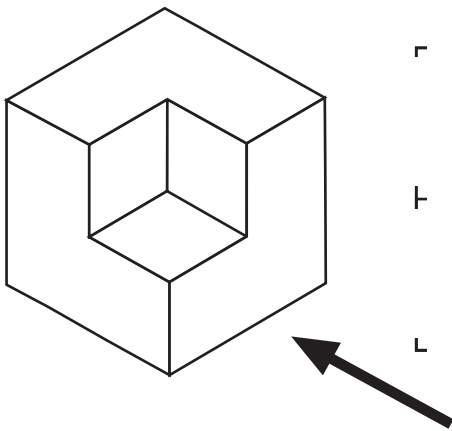

┌      ─      ㄣ

└      +      ㄣ

└      ⊥      ㄣ

┌	┐	┌	┌	┐	┌	┌	┐	┌
└	+	└	└	+	└	└	+	└
└	└	└	└	└	└	└	└	└

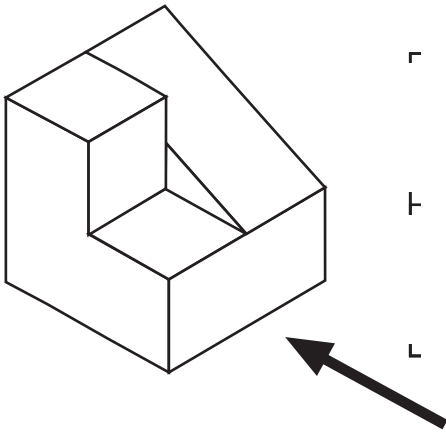

┌	┐	┌
└	+	└
└	└	└

┌	┐	┌	┌	┐	┌	┌	┐	┌
└	+	└	└	+	└	└	+	└
└	└	└	└	└	└	└	└	└

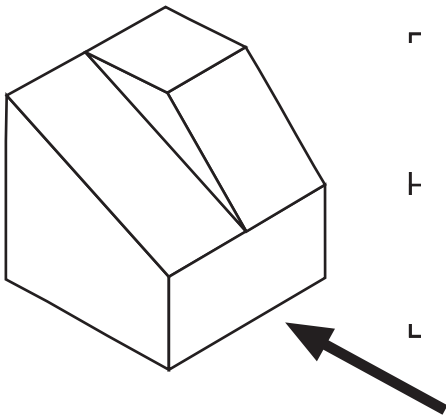

┌	┐	┌
└	+	└
└	└	└

┌      ┐      ┌      ┌      ┐      ┌      ┐      ┐      ┐      ┐  
└      +      ┘      └      +      ┘      └      +      ┘      └      +      ┘  
└      ⊥      ┘      └      ⊥      ┘      └      ⊥      ┘      └      ⊥      ┘

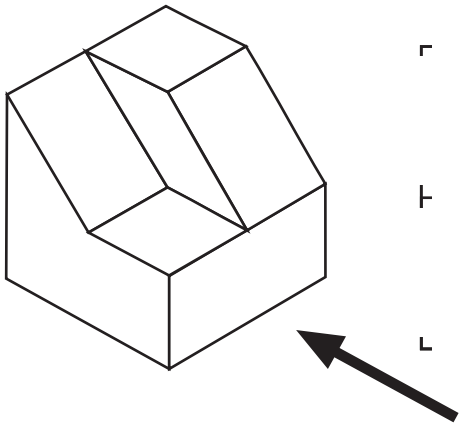

┌      ┐      ┌      ┐      ┌      ┐  
└      +      ┘      └      +      ┘      └      +      ┘  
└      ⊥      ┘      └      ⊥      ┘      └      ⊥      ┘

┌      ┐      ┌      ┐      ┌      ┐      ┌      ┐      ┌      ┐      ┌      ┐      ┌      ┐      ┌      ┐      ┌      ┐  
└      +      ┘      └      +      ┘      └      +      ┘      └      +      ┘      └      +      ┘      └      +      ┘      └      +      ┘      └      +      ┘  
└      ⊥      ┘      └      ⊥      ┘      └      ⊥      ┘      └      ⊥      ┘      └      ⊥      ┘      └      ⊥      ┘      └      ⊥      ┘

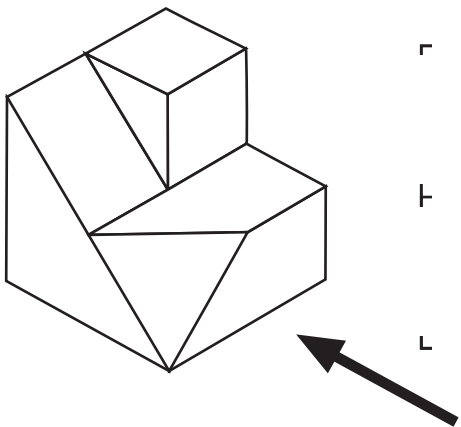

┌      ┐      ┌      ┐      ┌      ┐  
└      +      ┘      └      +      ┘      └      +      ┘  
└      ⊥      ┘      └      ⊥      ┘      └      ⊥      ┘

┌      ─      ㄣ      ┌      ─      ㄣ      ┌      ─      ㄣ  
└      +      ㄣ      └      +      ㄣ      └      +      ㄣ  
└      ⊥      ㄣ      └      ⊥      ㄣ      └      ⊥      ㄣ

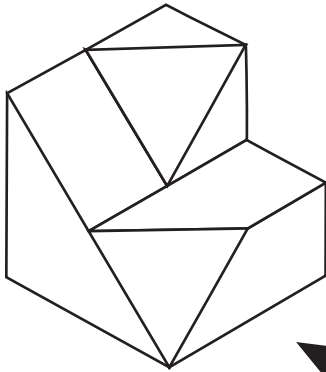

┌      ─      ㄣ  
└      +      ㄣ  
└      ⊥      ㄣ

┌      ─      ㄣ      ┌      ─      ㄣ      ┌      ─      ㄣ  
└      +      ㄣ      └      +      ㄣ      └      +      ㄣ  
└      ⊥      ㄣ      └      ⊥      ㄣ      └      ⊥      ㄣ

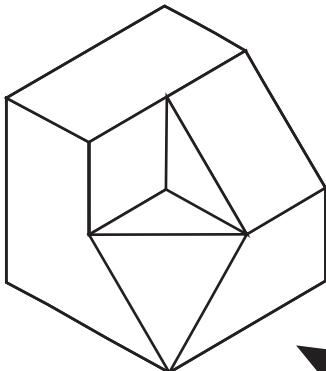

┌      ─      ㄣ  
└      +      ㄣ  
└      ⊥      ㄣ

┌	┐	└	┌	┐	└	┌	┐	└
└	+	└	└	+	└	└	+	└
└	└	└	└	└	└	└	└	└

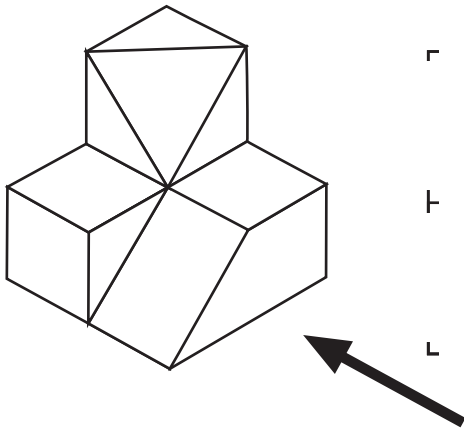

┌	┐	└
└	+	└
└	└	└

┌	┐	└	┌	┐	└	┌	┐	└
└	+	└	└	+	└	└	+	└
└	└	└	└	└	└	└	└	└

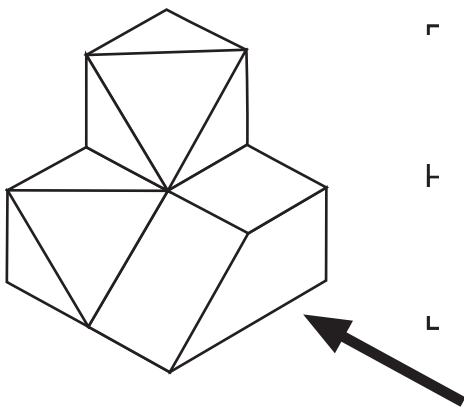

┌	┐	└
└	+	└
└	└	└

